

2 YEARS WARRANTY



# DRIJA

## Alemania 30

ELECTRIC

Estufa Eléctrica para Empotrar  
Electric Stove Built-In

**Ceika**  
Quemadores  
Hot Plate

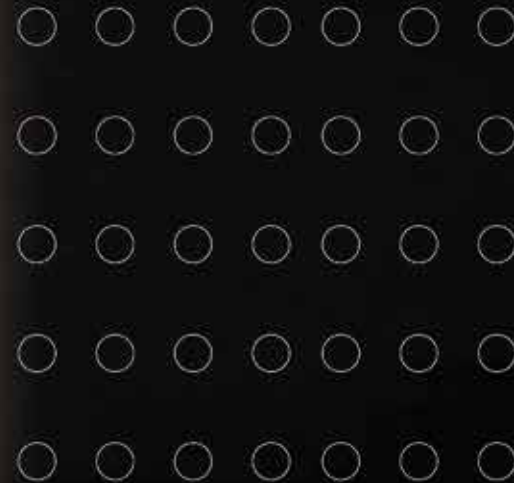
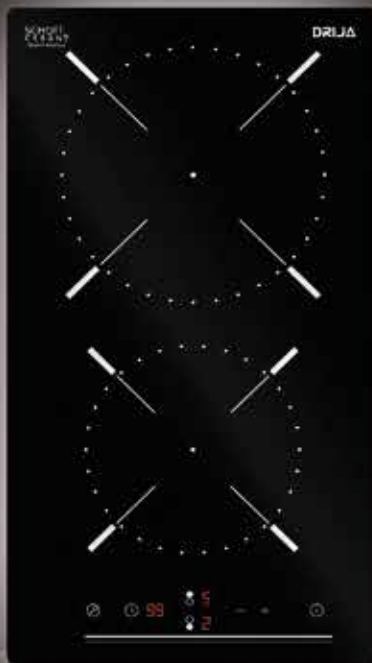

Estufa Eléctrica para Empotrar  
Electric Stove Built-In



TUTORIALS OF  
TECHNICAL SUPPORT

# USER MANUAL

220-240V / 50-60Hz

NOTA: Para adquirir accesorios y/o repuestos de este producto, contáctenos al call center (según el número de su país que le indique el certificado de garantía) o a nuestras redes sociales

NOTE: To purchase accessories and / or spare parts for this product, contact us at the call center (depending on the number of your country that indicates the warranty certificate) or our social networks

 [www.DrijaInternational.com](http://www.DrijaInternational.com)

**User Manual**  
ELECTRIC STOVE BUILT-IN | ALEMANIA 30



|                                    |    |
|------------------------------------|----|
| 1. INTRODUCTION .....              | 2  |
| 2. OPERATION AND MAINTENANCE ..... | 3  |
| 3. PRODUCT INTRODUCTION.....       | 6  |
| 4. CONTROL PANEL.....              | 6  |
| 5. TECHNICALSPECIFICATION.....     | 7  |
| 6. HOW TO USE.....                 | 9  |
| 7. COOKING GUIDE LINES .....       | 14 |
| 8. CARE AND CLEANING .....         | 16 |
| 9. INSTALLATION .....              | 18 |

## **1. INTRODUCTION**

### **SAFETY WARNINGS**

Your safety is important to us. Please read this information before using your cook top.

### **ELECTRICAL SHOCK HAZARD**

Disconnect the appliance from the mains electricity supply before carrying out any work or maintenance on it.

Connection to a good earth wiring system is essential and mandatory.

Alterations to the domestic wiring system must only be made by a qualified electrician.

Failure to follow this advice may result in electrical shock or death.

### **CUTHAZARD**

Take care - panel edges are Sharp.

Failure to use caution could result in injury or cuts.

### **IMPORTANT SAFETY INSTRUCTIONS**

Read these instructions carefully before installing or using this appliance.

No combustible material or products should be placed on this appliance at any time.

Please make this information available to the person responsible for installing the appliance as it could reduce your installation costs.

In order to avoid a hazard, this appliance must be installed according to these instructions for installation.

This appliance is to be properly installed and earthed only by a suitably qualified person.

This appliance should be connected to a circuit which incorporates an isolating switch providing full disconnection from the power supply.

Failure to install the appliance correctly could invalidate any warranty or liability claims.

## **2. OPERATION AND MAINTENANCE**

### **ELECTRICAL SHOCK HAZARD**

Do not cook on a broken or cracked stove. If the stove surface breaks or cracks, Turn the stove off immediately to the mains (wall switch) and contact a qualified technician.

- Switch the cook top off at the wall before cleaning or maintenance.
- Failure to follow this advice may result in electrical shock or death.

### **HEALTHHAZARD**

This appliance complies with electromagnetic safety standards.

•However, persons with cardiac pacemakers or other electrical implants (such as insulin pumps) must consult with their doctor or implant manufacturer before using this appliance to make sure that their implants will not be affected by the electromagnetic field.

•Failure to follow this advice may result in death.

### **HOT SURFACE HAZARD**

During use, accessible parts of this appliance will become hot enough to cause burns.

•Do not let your body, clothing, or any contact items and appropriate containers, come in contact with ceramic glass until the surface is cool.

•Metallic objects such as knives, forks, spoons and lids should not be placed on the hob surface since they can get hot

•Keep children away.

•Handles of saucepans may be hot to touch. Check saucepan handles do not overhang other cooking zones that are on. Keep handles out of reach of children.

•Failure to follow this advice could result in burns and scalds.

### **CUTHAZARD**

The razor-sharp blade of a cook top scraper is exposed when the safety cover is retracted. Use with extreme care and always store safely and out of reach of children.

•Failure to use caution could result in injury or cuts.



## **IMPORTANT SAFETY INSTRUCTIONS**

Never leave the appliance unattended when in use. Boil over causes smoking and greasy spillovers that may ignite.

Never use your appliance as a work or storage surface.

Never leave any objects or utensils on the appliance.

Do not place or leave any magnet sable objects (e.g. credit cards, memory cards) or electronic devices (e.g. computers, MP3 players) near the appliance, as they may be affected by its electromagnetic field.

Never use your appliance for warming or heating the room.

After use, always turn off the cooking zones and the cook top as described in this manual (i.e. by using the touch controls). Do not rely on the pan detection feature to turn off the cooking zones when you remove the pans.

Do not allow children to play with the appliance or sit, stand, or climb on it.

Do not store items of interest to children in cabinets above the appliance. Children climbing on the cook top could be seriously injured.

Do not leave children alone or unattended in the area where the appliance is in use.

Children or persons with a disability which limits their ability to use the appliance should have a responsible and competent person to instruct them in its use. The instructor should be satisfied that they can use the appliance without danger to themselves or their surroundings.

Do not repair or replace any part of the appliance unless specifically recommended in the manual. All other servicing should be done by a qualified technician.

Do not use a steam cleaner to clean your cook top.

Do not place or drop heavy objects on your cook top.

Do not stand on your cook top.

Do not use pans with jagged edges or drag pans across the Ceramic glass surface as this can scratch the glass.

Do not use scourers or any other harsh abrasive cleaning agents to clean your cook top, as these can scratch the Ceramic glass.

If the supply cord is damaged, it must be replaced by the manufacturer, its service agent or similarly qualified persons in order to avoid a hazard.

This appliance is intended to be used in household and similar applications such as: -staff kitchen areas in shops, offices and other working environments; -farm houses; -by clients in hotels, motels and other residential type environments; -bed and breakfast type environments.

**WARNING:** The appliance and its accessible parts become hot during use.

Care should be taken to avoid touching heating elements.

Children less than 8 years of age shall be kept away unless continuously supervised.

This appliance can be used by children aged from 8 years and above and persons with reduced physical, sensory or mental capabilities or lack of experience and knowledge if they have been given supervision or instruction concerning use of the appliance in a safe way and understand the hazards involved.

Children shall not play with the appliance. Cleaning and user maintenance shall not be made by children without supervision.

**WARNING:** Unattended cooking on a hob with fat or oil can be dangerous and may result in fire. NEVER try to extinguish a fire with water, but switch off the appliance and then cover flame e.g. with a lid or a fire blanket.

**WARNING:** Danger of fire: do not store items on the cooking surfaces.

**Warning:** If the surface is cracked, switch off the appliance to avoid the possibility of electric shock, for hob surfaces of glass-ceramic or similar material which protect live parts

A steam cleaner is not to be used.

The appliance is not intended to be operated by means of an external timer or separate remote-control system.

## **CONGRATULATIONS ON THE PURCHASE OF YOUR NEW CERAMIC HOB.**

We recommend that you spend some time to read this Instruction / Installation Manual in order to fully understand how to install correctly and operate it. For installation, please read the installation section.

Read all the safety instructions carefully before use and keep this Instruction / Installation Manual for future reference.

### 3. PRODUCT INTRODUCTION

#### TOP VIEW

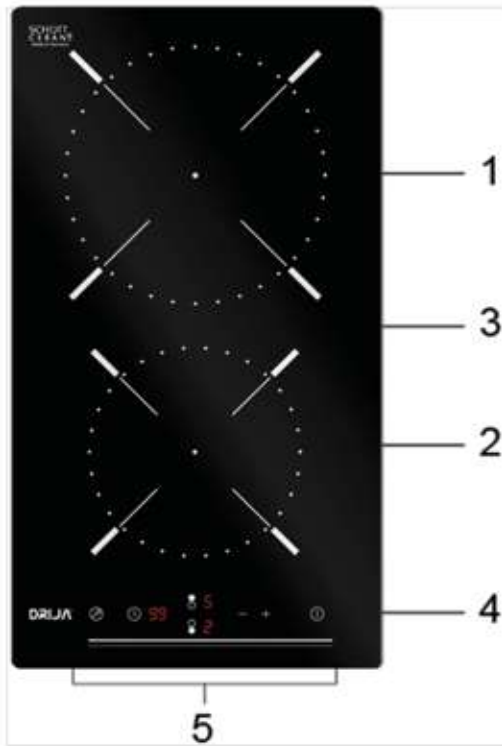

1. Max. 2000 W zone / 180 mm
2. Max. 1500 W zone / 145 mm
3. Glass plate
4. ON / OFF
5. Control panel

### 4. CONTROL PANEL

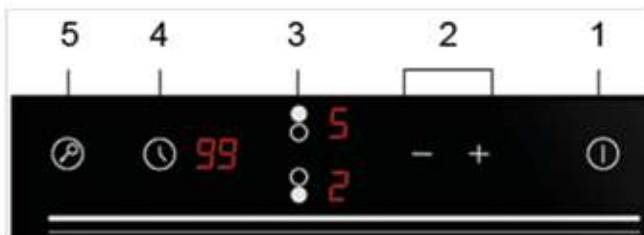

1. ON/OFF control
2. Power / Timer regulating controls
3. Heating zone selection controls
4. Timer control
5. Key lock control



## PRODUCT INFORMATION

The microcomputer ceramic cooker hob can meet different kinds of cuisine demands because of resistance wire heating, micro-computerized control and multi-power selection, really the optimal choice for modern families.

The ceramic cooker hob centers on customers and adopts personalized design. The hob has safe and reliable performances, making your life comfortable and enabling to fully enjoy the pleasure from life.

## WORKING PRINCIPLE

This ceramic cooker hob directly employs resistance wire heating, and adjusts the output power by the power regulation with the touch controls.

## BEFORE USING YOUR NEW CERAMIC HOB

- Read this guide, taking special note of the 'Safety Warnings' section.
- Remove any protective film that may still be on your ceramic hob.

## 5. TECHNICAL SPECIFICATION

|                                 |                   |
|---------------------------------|-------------------|
| Model                           | Alemania 30       |
| Cooking Zones                   | 2 Zones           |
| Supply Voltage                  | 220-240V~ 50/60Hz |
| Installed Electric Power        | 3000 W            |
| Product Size D×W×H(mm)          | 288X520X55        |
| Building-in Dimensions A×B (mm) | 268X500           |

Weight and Dimensions are approximate. Because we continually strive to improve our products we may change specifications and designs without prior notice.



## OPERATION OF PRODUCT

### TOUCH CONTROLS

The controls respond to touch, so you don't need to apply any pressure. Use the ball of your finger, not its tip.



You will hear a beep each time a touch is registered.

Make sure the controls are always clean, dry, and that there is no object (e.g. a utensil or a cloth) covering them. Even a thin film of water may make the controls difficult to operate.

### *Choosing the right Cookware*

Do not use cookware with jagged edges or a curved base.



Make sure that the base of your pan is smooth, sits flat against the glass, and is the same size as the cooking zone. Always centre your pan on the cooking zone.

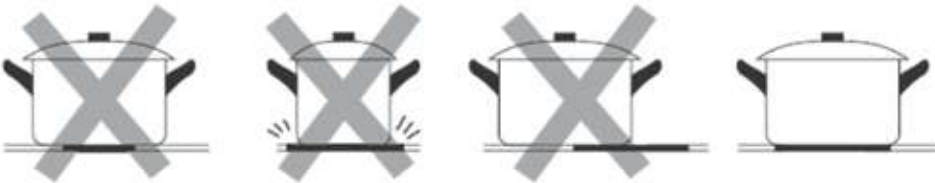



Always lift pans off the ceramic hob – do not slide, or they may scratch the glass.



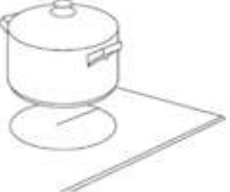

## 6. HOW TO USE

### START COOKING

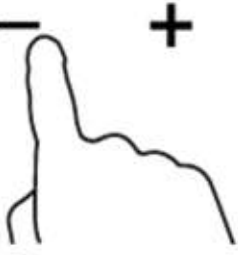
After power on, the buzzer beeps once, all the indicators light up for 1 second then go out, indicating that the ceramic hob has entered the stat of standby mode.

|  |  |
|--|--|
| <p>Touch the ON/OFF control. all the indicators show “-“</p>   |    |
| <p>Place a suitable pan on the cooking zone that you wish to use.</p> <ul style="list-style-type: none"><li>• Make sure the bottom of the pan and the surfaces of the cooking zone are clean and dry.</li></ul>  |   |
| <p>Touching the heating zone selection control</p>   |  |
| <p>Select a heat setting by touching the “-“ or “+“ control.</p> <ul style="list-style-type: none"><li>• If you don't choose a heat setting within 1 minute, the ceramic hob will automatically switch off. You will need to start again at step 1.</li><li>• You can modify the heat setting at any time during cooking.</li><li>• By holding down either of these buttons, the value will adjust up or down.</li></ul> |  |

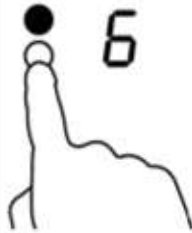
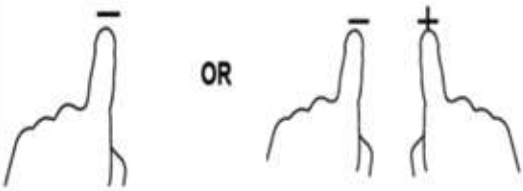
## FINISHCOOKING

|   |   |
|---|---|
| <p>Touching the heating zone selection control that you wish to switch off</p>                      |   |
| <p>Turn the cooking zone off by scrolling down to "0" or touching "-" and "+" control together.</p> |   |
| <p>Turn the whole cook top off by touching the ON/OFF control</p>                                   |  |



### **Beware of hot surfaces**

"H" will show which cooking zone is hot to touch. It will disappear when the surface has cooled down to a safe temperature. It can also be used as an energy saving function if you want to heat further pans, use the hotplate that is still hot.





## **LOCKING THE CONTROLS**

You can lock the controls to prevent unintended use (for example children accidentally turning the cooking zones on).

When the controls are locked, all the controls except the ON/OFF control are disabled.

| <b>To lock the controls</b>                  |                                    |
|--|------------------------------------|
| Touch the lock control                       | The timer indicator will show "Lo" |
| <b>To unlock the controls</b>                |                                    |
| Make sure the ceramic hob is turned on       |                                    |
| Touch and hold the lock control for a while. |                                    |



When the hob is in the lock mode, all the controls are disabling except the ON/OFF  , you can always turn the ceramic hob off with the ON/OFF  control in an emergency, but you shall unlock the hob first in the next operation.

## **TIMER CONTROL**



You can use the timer in two different ways:

- a) You can use it as a minute minder. In this case, the timer will not turn any cooking zone off when the set time is up.
- b) You can set it to turn one or more cooking zones off after the set time is up.
  - The timer of maximum is 99 minutes



## USING THE TIMER AS A MINUTE MINDER

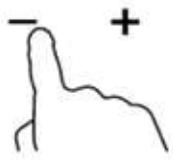

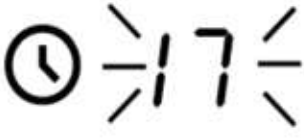
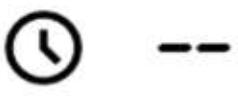



If you are not selecting any cooking zone

|   |  |
|---|--|
| <p>Make sure the cook top is turned on.</p> <p>Note: you can use the minute minder even if you're not selecting any cooking zone.</p>   |   |
| <p>Touch the timer control, the timer indicator will flash; Adjust the timer setting by touch the "-" or "+" controls. The minute minder indicator will start flashing and will show in the timer display</p> |    |
| <p>Touching the "-" and "+" together, the timer is cancelled, and the "--" will show in the minute display.</p>   |  |
| <p>When the time is set, it will begin to count down immediately. The display will show the remaining time and the timer indicator will flash for 5 seconds</p>   |  |

Hint:

- a) Touch the "-" or "+" control of the timer once to decrease or increase by 1 minute.
- b) Touch and hold the "-" or "+" control of the timer to decrease or increase by 10 minutes.
- c) If the setting time exceeds 99 minutes, the timer will automatically return to 0 minute.

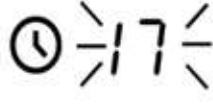
**Setting the timer to turn one or more cooking zones off**

| <b>Set one zone</b>   |  |
|---|--|
| Touch the zone you want to set  |    |
| Touch the timer control, the timer indicator show "10"  |    |
| Set the time by touching the "-" or "+" control of the timer  |    |
| Touching the "-" and "+" together, the timer is cancelled, and the will show "--" in the minute display.  |   |
| When the time is set, it will begin to count down immediately. The display will show the remaining time and the timer indicator flash for 5 seconds |  |
| When cooking timer expires, the corresponding cooking zone will be switched off automatically.  |  |

Note:

The red dot next to power level indicator will illuminate indicating that zone is selected.

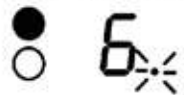

If you want to change the time after the timer is set, you have to start from step 1.

The method for setting two zones is the same as mentioned above.

## **OVER-TEMPERATURE PROTECTION**

A temperature sensor equipped can monitor the temperature inside the ceramic hob. When an excessive temperature is monitored, the ceramic hob will stop operation automatically.



## RESIDUAL HEATWARNING

When the hob has been operating for some time, there will be some residual heat. The letter "H" appears to warn you to keep away from it.

## DEFAULT WORKING TIMES

Another safety feature of the hob is automatic shutdown. This occurs whenever you forget to switch off a cooking zone. The default shutdown times are shown in the table below:

|                              |   |   |   |   |   |   |   |   |   |
|------------------------------|---|---|---|---|---|---|---|---|---|
| Power level                  | 1 | 2 | 3 | 4 | 5 | 6 | 7 | 8 | 9 |
| Default working timer (hour) | 8 | 8 | 8 | 4 | 4 | 4 | 2 | 2 | 2 |

## 7. COOKING GUIDE LINES



Take care when frying as the oil and fat heat up very quickly, particularly if you're using Power Boost. At extremely high temperatures oil and fat will ignite spontaneously and this presents a serious fire risk.

## COOKING TIPS

When food comes to the boil, reduce the temperature setting.

Using a lid will reduce cooking times and save energy by retaining the heat.

Minimize the amount of liquid or fat to reduce cooking times.

Start cooking on a high setting and reduce the setting when the food has heated through.

## SIMMERING, COOKING RICE

- Simmering occurs below boiling point, at around 85°C, when bubbles are just rising occasionally to the surface of the cooking liquid. It is the key to delicious soups and tender stews because the flavors develop without overcooking the food. You should also cook egg-based and flour thickened sauces below boiling point.
- Some tasks, including cooking rice by the absorption method, may require a setting higher than the lowest setting to ensure the food is cooked properly in the time recommended.



## SEARINGSTEAK

**To cook juicy flavorsome steaks:**

1. Choose a ceramic compatible flat-based wok or a large frying pan.
2. Have all the ingredients and equipment ready. Stir-frying should be quick. If cooking large quantities, cook the food in several smaller batches.
3. Preheat the pan briefly and add two tablespoons of oil.
4. Cook any meats first, put it aside and keep warm.
5. Stir-fry the vegetables. When they are hot but still crisp, turn the cooking zone to a lower setting, return the meat to the pan and add your sauce.

## FORSTIR-FRYING

1. Choose a ceramic compatible flat-based wok or a large frying pan.
2. Have all the ingredients and equipment ready. Stir-frying should be quick. If cooking large quantities, cook the food in several smaller batches.
3. Preheat the pan briefly and add two tablespoons of oil.
4. Cook any meat first, put it aside and keeps warm.
5. Stir-fry the vegetables. When they are hot but still crisp, turn the cooking zone to a lower setting, return the meat to the pan and add your sauce.
6. Stir the ingredients gently to make sure they are heated through.

## SERVEY IMMEDIATEL.

## HEATSETTINGS

The settings below are guidelines only. The exact setting will depend on several factors, including your cookware and the amount you are cooking. Experiment with the Ceramic hob to find the settings that best suit you.

| Control de temperature | Suitability   |
|------------------------|---|
| 1 - 2                  | <ul style="list-style-type: none"><li>• Delicate warming for small amounts of food</li><li>• Melting chocolate, butter, and foods that burn quickly</li><li>• Gentle simmering</li><li>• Slow warming</li></ul> |
| 3 - 4                  | <ul style="list-style-type: none"><li>• Reheating</li><li>• Rapid simmering</li><li>• Cooking rice</li></ul>  |
| 5 - 6                  | <ul style="list-style-type: none"><li>• Pancakes</li></ul>  |
| 7 - 8                  | <ul style="list-style-type: none"><li>• Sautéing</li><li>• Cooking pasta</li></ul>  |
| 9                      | <ul style="list-style-type: none"><li>• Stir-frying</li><li>• Searing</li><li>• Bringing soup to the boil</li><li>• Boiling water</li></ul>   |



## 8. CARE AND CLEANING

| What?  | How?   | Important!  |
|--|--|---|
| Everyday soiling on glass (fingerprints, marks, stains left by food or non-sugary spillovers on the glass) | <ol style="list-style-type: none"> <li>1. Switch the power to the cook top off.</li> <li>2. Apply a cook top cleaner while the glass is still warm (but not hot!)</li> <li>3. Rinse and wipe dry with a clean cloth or paper towel.</li> <li>4. Switch the power to the cook top back on.</li> </ol>   | <ul style="list-style-type: none"> <li>• When the power to the cook top is switched off, there will be no 'hot surface' indication but the cooking zone may still be hot! Take extreme care.</li> <li>• Heavy-duty scourers, some nylon scourers and harsh/abrasive cleaning agents may scratch the glass. Always read the label to check if you're cleaner or scourer is suitable.</li> <li>• Never leave cleaning residue on the cook top: the glass may become stained.</li> </ul> |
| Boil over's, melts, and hot sugary spills on the glass   | <p>Remove these immediately, palette knife or razor blade scraper suitable for Ceramic glass cook tops, but beware of hot cooking zone surfaces:</p> <ol style="list-style-type: none"> <li>1. Switch the power to the cook top off at the wall.</li> <li>2. Hold the blade or utensil at a 30° angle and scrape the soiling or spill to a cool area of the cook top.</li> <li>3. Clean the soiling or spill up with a dish cloth or paper towel.</li> <li>4. Follow steps 2 to 4 for 'Everyday soiling on glasses above.</li> </ol> | <ul style="list-style-type: none"> <li>• Remove stains left by melts and sugary food or spillovers as soon as possible. If left to cool on the glass, they may be difficult to remove or even permanently damage the glass surface.</li> <li>• Cut hazard: when the safety cover is retracted, the blade in a scraper is razor-sharp. Use with extreme care and always store safely and out of reach of children.</li> </ul>  |
| Spillovers on the touch controls   | <ol style="list-style-type: none"> <li>1. Switch the power to the cook top off.</li> <li>2. Soak up the spill</li> <li>3. Wipe the touch control area with a clean damp sponge or cloth.</li> <li>4. Wipe the area completely dry with a paper towel.</li> <li>5. Switch the power to the cook top back on.</li> </ol>   | <ul style="list-style-type: none"> <li>• The cook top may beep and turn itself off, and the touch controls may not function while there is liquid on them. Make sure you wipe the touch control area dry before turning the cook top back on.</li> </ul>  |

## HINTS AND TIPS

| <b>Problem</b>                                     | <b>Possible causes</b>  | <b>What to do</b>  |
|--|---|--|
| The cook top not<br>Be turned on.                  | No power.   | Make sure the ceramic hob is<br>Connected to the power supply and that it are<br>switched on.<br><br>Check whether there is a power outage in<br>your home or area. If<br><br>You've checked everything and the problem<br>persist, call a qualified technician. |
| The touch controls are<br>unresponsive.            | The controls are locked.  | Unlock the controls. See the section 'Using<br>your hob' for instructions.   |
| The touch controls are<br>difficult to operate.    | There may be a slight film of water<br>over the controls or you may be<br>using the tip of your finger when<br>touching the controls. | Make sure the touch control area is dry and<br>use the ball of your finger when touching the<br>controls.  |
| The glass is being<br>scratched.                   | Rough-edged cookware.<br><br>Unsuitable, abrasive scourer or<br>cleaning products being used.   | Use cookware with flat and smooth bases.<br>See 'Choosing the right cook ware'. See<br>'Care and cleaning'.  |
| Some pans make<br>crackling or clicking<br>noises. | This may be caused by the<br>construction of your cookware<br>(layers of different metals vibrating<br>differently).                  | This is normal for cookware and does not<br>indicate a fault.  |

## 9. INSTALLATION

### SELECTION OF INSTALLATION EQUIPMENT

1. Cut out the work surface according to the sizes shown in the drawing.

For the purpose of installation and use, a minimum of 50mm space shall be preserved around the hole.

Be sure the thickness of the work surface is at least 30mm. Please select heat-resistant and insulated work surface material (Wood and similar fibrous or hygroscopic material shall not be used as work surface material unless impregnated) to avoid the electrical shock and larger deformation caused by the heat radiation from the hotplate. As shown below:



Note: The safety distance between the sides of the hob and the inner surfaces of the worktops should be at least 3mm.

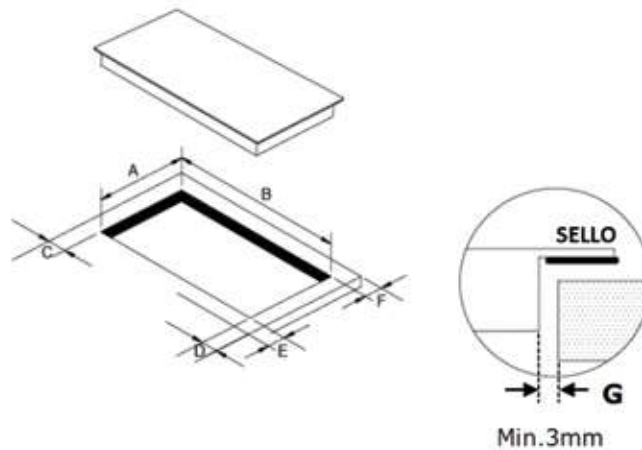

| A                          | B                          | C            | D         | E            | F            | G        |
|----------------------------|----------------------------|--------------|-----------|--------------|--------------|----------|
| 268 <sup>+4</sup><br>-0 mm | 500 <sup>+4</sup><br>-0 mm | 50mm<br>mini | 50mm mini | 50mm<br>mini | 50mm<br>mini | 3mm mini |

2. The ceramic cooker hob can be used on the table top of cabinet. The ceramic hob should be placed horizontally. As shown below:

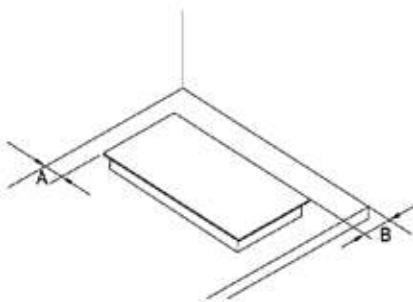

| A         | B         |
|-----------|-----------|
| 50mm mini | 50mm mini |

Under any circumstances, make sure the ceramic cooker hob is well ventilated and the air inlet and outlet are not blocked. Ensure the ceramic cooker hob is in good work state. As shown below



Note: The safety distance between the hotplate and the cupboard above the hotplate should be at least 760mm.

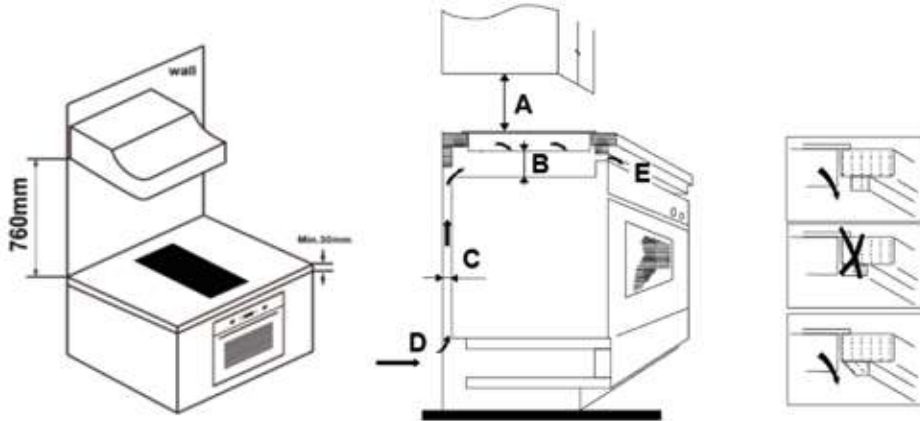

| A(mm) | B(mm)   | C(mm)   | D          | E            |
|-------|---------|---------|------------|--------------|
| 760   | 50 mini | 20 mini | Air intake | Air exit 5mm |

**WARNING: Ensuring Adequate Ventilation**

Make sure the ceramic hob is well ventilated and that air inlet and outlet are not blocked. In order to avoid accidental touch with the overheating bottom of the hob, or getting unrespectable electric shock during working, it is necessary to put a wooden insert, fixed by screws, at a minimum distance of 50mm from the bottom of the hob. Follow the requirements below.



There are ventilation holes around outside of the hob. YOU MUST ensure these holes are not blocked by the worktop when you put the hob into position.



- Be aware that the glue that joins the plastic or wooden material to the furniture has to resist to temperature not below 150°C, to avoid the unstuck of the paneling.
- The rear wall, adjacent and surrounding surfaces must therefore be able to withstand a temperature of 90°C.



## BEFORE LOCATING THE FIXING BRACKETS

The unit should be placed on a stable, smooth surface (use the packaging). Do not apply force onto the controls protruding from the hob.

Fix the hob on the work surface by screw four brackets on the bottom of hob (see picture) after installation. Adjust the bracket position to suit for different work surface's thickness.

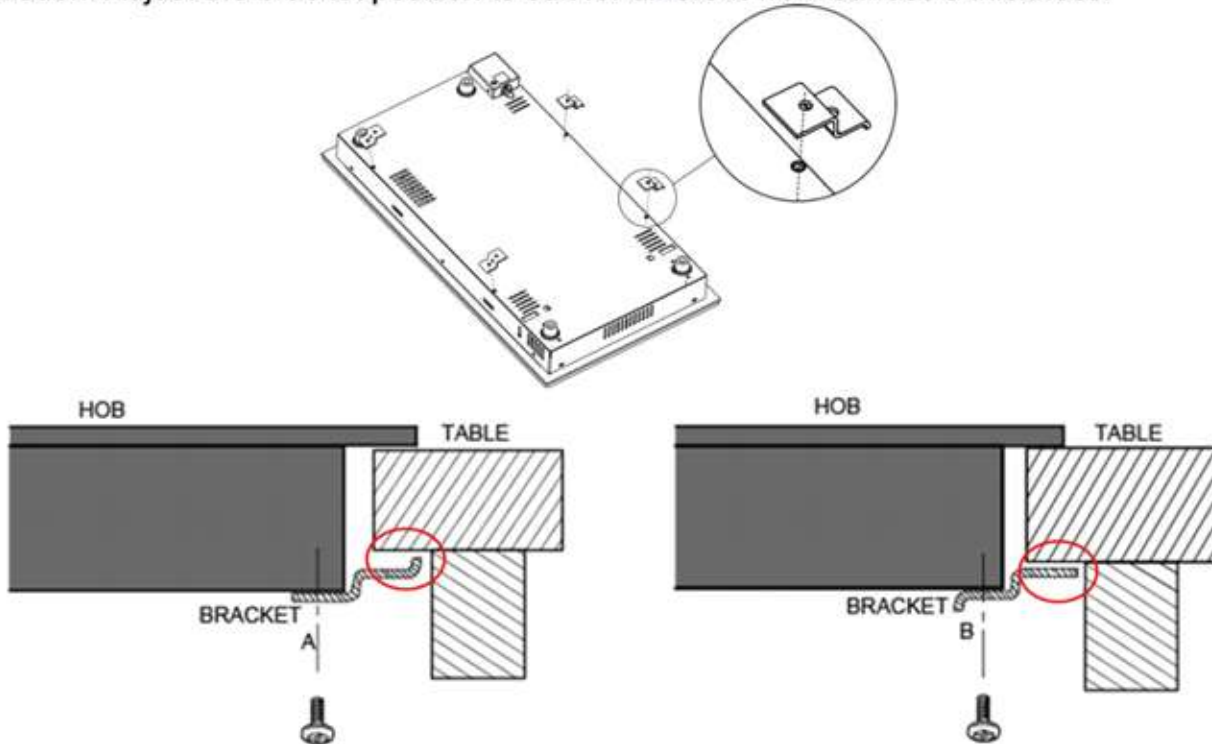

Under any circumstances, the brackets cannot touch with the inner surfaces of the worktop after installation (see picture).

## CAUTIONS

1. The ceramic cooker hob must be installed by qualified personnel or technicians. We have professionals at your service. Please never conduct the operation by yourself.
2. The ceramic cooker hob shall not be mounted to cooling equipment, dishwashers and rotary dryers.
3. The ceramic cooker hob shall be installed such that better heat radiation can be ensured to enhance its reliability.
4. The wall and induced heating zone above the work surface shall withstand heat.
5. To avoid any damage, the sandwich layer and adhesive must be resistant to heat.
6. A steam cleaner is not to be used.
7. This ceramic can be connected only to a supply with system impedance no more than 0.427 ohm. In case necessary, please consult your supply authority for System impedance information.

## **CONNECTING THE HOB TO THE MAINS POWER SUPPLY**

The electrical power system of an electric or induction cooktop, must include:

- A double breaker of 20A on each side minimum.
- A number 10-gauge cabling.

It must be installed to a ground source not a neutral!

The ground source will protect the equipment of any sudden change in voltage and will prevent electrical damage overtime.

The power supply should be connected in compliance with the relevant standard, or a single-pole circuit breaker. The method of connection is shown below.

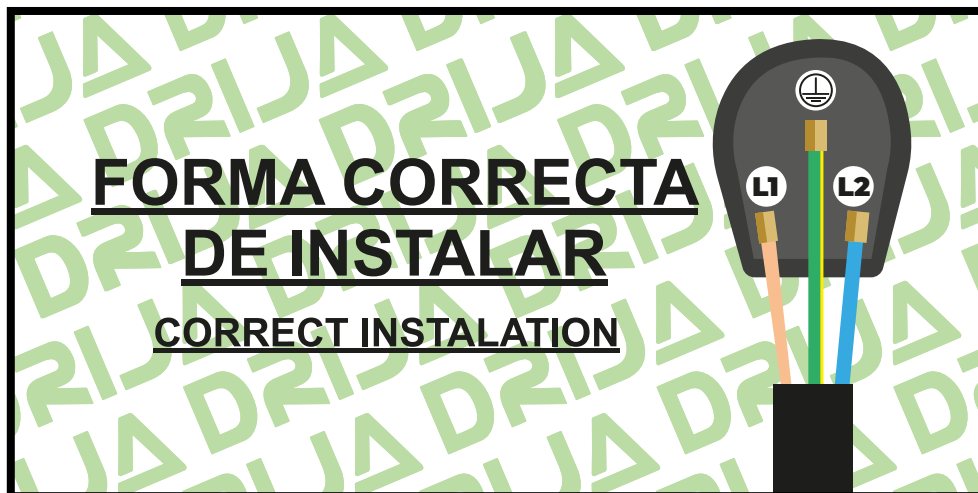

1. If the cable is damaged or needs replacing, this should be done by an after-sales technician using the proper tools, so as to avoid any accidents.
2. If the appliance is being connected directly to the mains supply, an omnipolar circuit breaker must be installed with a minimum gap of 3mm between the contacts.
3. The installer must ensure that the correct electrical connection has been made and that it complies with safety regulations.
4. The cable must not be bent or compressed.
5. The cable must be checked regularly and only replaced by a properly qualified person.



The bottom surface and the power cord of the hob are not accessible after installation.



**DISPOSAL: Do not dispose this product as unsorted municipal Waste. Collection of Such waste separately for special treatment is necessary.**

This appliance is labeled in compliance with European directive 2012/19/EU for Waste Electrical and Electronic Equipment (WEEE). By ensuring that this appliance is disposed of correctly, you will help prevent any possible damage to the environment and to human health, which might otherwise be caused if it were disposed of in the wrong way.

The symbol on the product indicates that it may not be treated as normal household waste. It should be taken to a collection point for the recycling of electrical and electronic goods.

This appliance requires specialist waste disposal. For further information regarding the treatment, recovery and recycling of this product please contact your local council, your household waste disposal service, or the shop where you purchased it.

For more detailed information about treatment, recovery and recycling of this product, please contact your local city office, your household waste disposal service or the shop where you purchased the product.

**PROTEGE**  
**TU GARANTIA**  
La garantía **NO** cubre daños causados por su mala instalación

---

**WARRANTY DISCLAIMER**  
Warranty doesn't cover any product damage due to wrong instalation